

Component General, Inc.

■ Stripline Base Mounted Resistors

■ MECHANICAL SPECIFICATIONS



Heat Sink : Copper, Nickel Plated per QQ-N-290.
 Substrate : Beryllium Oxide Ceramic.
 Contact : Beryllium Copper, Gold Plated per MIL-G-45204.
 Thickness : 0.004" ± 0.002".
 Cover : Alumina Ceramic.
 Tolerance : ± 0.010" unless specified

2 hole base mounted resistors product selection chart

CGI P/N	Power	Resistance (Ohms)	Frequency Range	Standard Tolerance
Note: Click a part number from the list below to see a data sheet for that part.				
CBR-10	10 W	10 - 1000	DC - 4.0 GHz	5 %
CBR-40	40 W	10 - 1000	DC - 6.0 GHz	5 %
CBR-40-1	40 W	10 - 1000	DC - 6.0 GHz	5 %
CBR-75	40 W	10 - 1000	DC - 1.5 GHz	5 %
CBR-125	125 W	10 - 1000	DC - 3.0 GHz	5 %
CBR-150	150 W	10 - 1000	DC - 1.0 GHz	5 %
CBR-150-1	150 W	10 - 1000	DC - 2.0 GHz	5 %
CBR-150-2	150 W	10 - 1000	DC - 1.0 GHz	5 %
CBR-150-3	150 W	10 - 1000	DC - 2.0 GHz	5 %
CBR-150-4	150 W	10 - 1000	DC - 2.0 GHz	5 %
CBR-150-5	150 W	10 - 1000	DC - 1.0 GHz	5 %
CBR-250	250 W	10 - 1000	DC - 1.0 GHz	5 %
CBR-250-1	250 W	10 - 1000	DC - 1.0 GHz	5 %
CBR-250-2	250 W	10 - 1000	DC - 1.0 GHz	5 %

Component General, Inc.

■ Stripline Base Mounted Resistors

■ MECHANICAL SPECIFICATIONS



Heat Sink :	Copper, Nickel Plated per QQ-N-290.
Substrate :	Beryllium Oxide Ceramic.
Contact :	Beryllium Copper, Gold Plated per MIL-G-45204.
Thickness :	0.004" ± 0.002".
Cover :	Alumina Ceramic.
Tolerance :	± 0.010" unless specified

2 hole base mounted resistors product selection chart

CGI P/N	Power	Resistance (Ohms)	Frequency Range	Standard Tolerance
Note: Click a part number from the list below to see a data sheet for that part.				
CBR-250-4	250 W	10 - 1000	DC - 2.4 GHz	5 %
CBR-250-5	250 W	10 - 1000	DC - 2.4 GHz	5 %
CBR-370	370 W	10 - 1000	DC - .75 GHz	5 %
CBR-400	400 W	10 - 1000	DC - .75 GHz	5 %

Component General, Inc.

P/N: CBR-10

Stripline Base Mounted Resistors

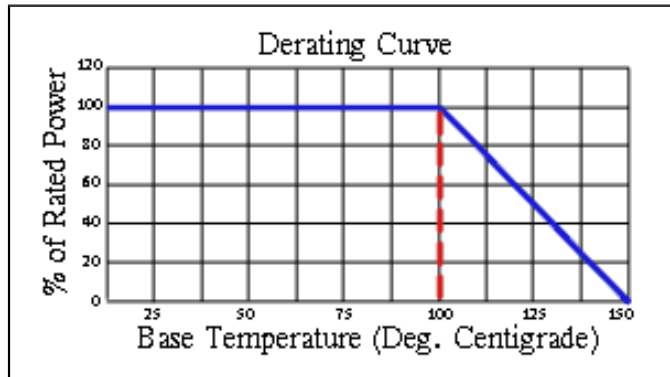
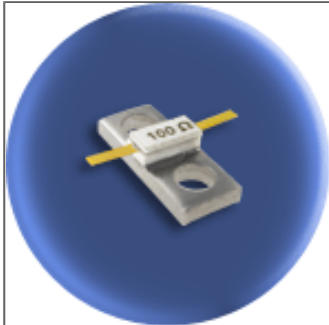

Mechanical Specifications

Covers:

Alumina Ceramic.

Substrate:

Beryllium Oxide Ceramic.

Contact:

Beryllium Copper, Gold Plated per MIL-G-45204.
Length: 0.125" Min., Width: 0.040",
Thickness: 0.004" \pm 0.002".

Heat Sink:

Copper, Nickel Plated per QQ-N-290.

Tolerance:

\pm 0.010" unless specified.

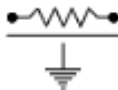

Note: The use of thermal mounting compound is recommended.

Electrical Specifications

Resistance Value:

10 - 1000 Ω or as required. Other values available upon request.

Frequency Range:

DC - 4.0 GHz

Standard Resistance Tolerance:

\pm 5% Other tolerances available upon request.

Part Dimensions

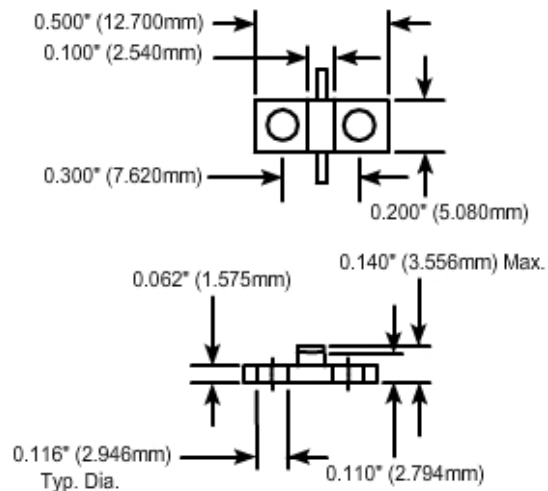

Component General, Inc.

P/N: CBR-40

Stripline Base Mounted Resistors

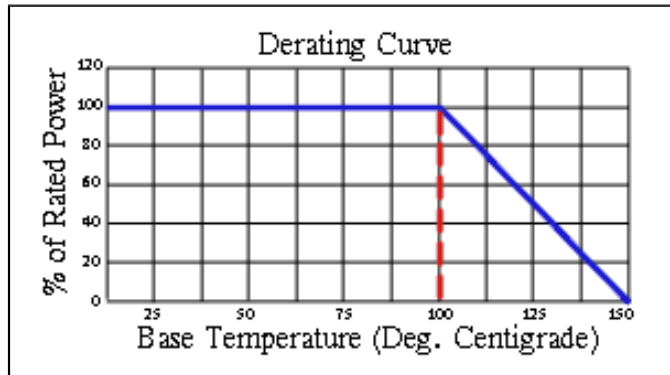
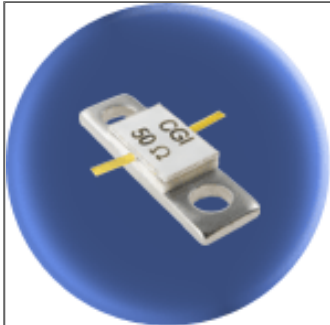

Mechanical Specifications

Covers:

Alumina Ceramic.

Substrate:

Beryllium Oxide Ceramic.

Contact:

Beryllium Copper, Gold Plated per MIL-G-45204.
Length: 0.125" Min., Width: 0.040",
Thickness: 0.004" \pm 0.002".

Heat Sink:

Copper, Nickel Plated per QQ-N-290.

Tolerance:

\pm 0.010" unless specified.

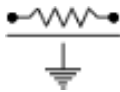

Note: The use of thermal mounting compound is recommended.

Electrical Specifications

Resistance Value:

10 - 1000 Ω or as required. Other values available upon request.

Frequency Range:

DC - 6.0 GHz

Standard Resistance Tolerance:

\pm 5% Other tolerances available upon request.

Part Dimensions

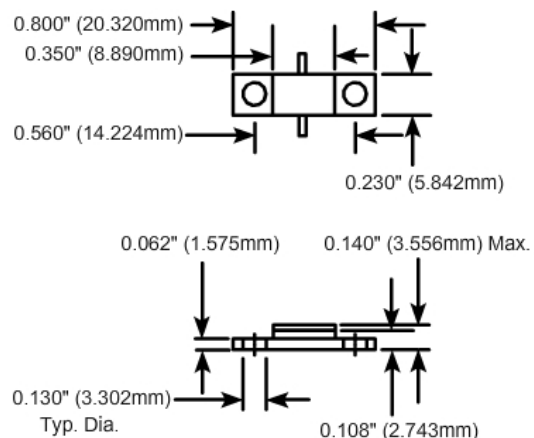

Component General, Inc.

P/N: CBR-40-1

Stripline Base Mounted Resistors

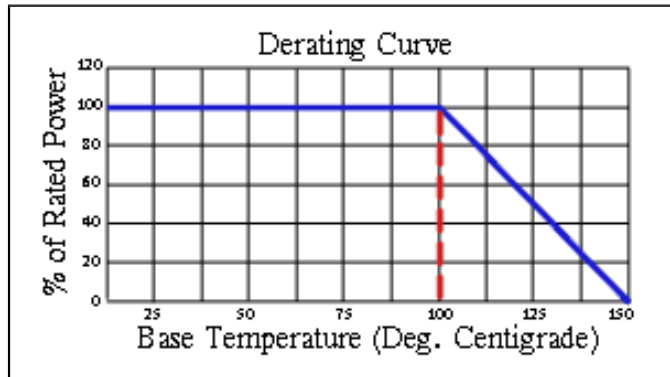
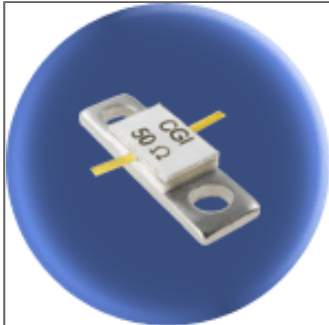

Mechanical Specifications

Covers:

Alumina Ceramic.

Substrate:

Beryllium Oxide Ceramic.

Contact:

Beryllium Copper, Gold Plated per MIL-G-45204.
Length: 0.125" Min., Width: 0.040",
Thickness: 0.004" \pm 0.002".

Heat Sink:

Copper, Nickel Plated per QQ-N-290.

Tolerance:

\pm 0.010" unless specified.

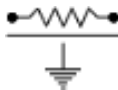

Note: The use of thermal mounting compound is recommended.

Electrical Specifications

Resistance Value:

10 - 1000 Ω or as required. Other values available upon request.

Frequency Range:

DC - 6.0 GHz

Standard Resistance Tolerance:

\pm 5% Other tolerances available upon request.

Part Dimensions

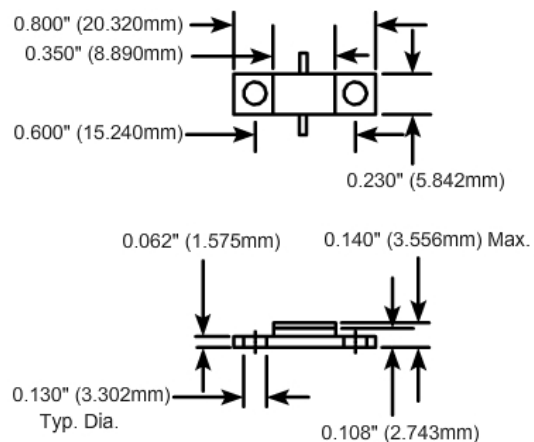

Component General, Inc.

P/N: CBR-75

Stripline Base Mounted Resistors

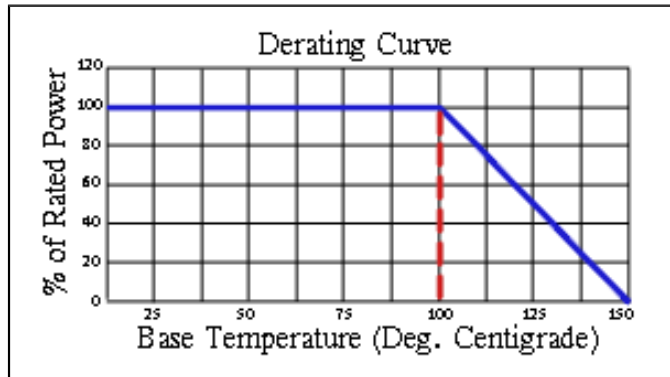
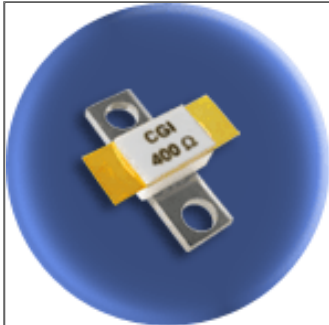

Mechanical Specifications

Covers:

Alumina Ceramic.

Substrate:

Beryllium Oxide Ceramic.

Contact:

Beryllium Copper, Gold Plated per MIL-G-45204.
Length .125" min., Width 0.250"
Thickness 0.004" ± 0.002".

Heat Sink:

Copper, Nickel Plated per QQ-N-290.

Tolerance:

± 0.010" unless specified.

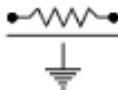

Note: The use of thermal mounting compound is recommended.

Electrical Specifications

Resistance Value:

10 - 1000 Ω or as required. Other values available upon request.

Frequency Range:

DC - 1.5 GHz

Standard Resistance Tolerance:

± 5% Other tolerances available upon request.

Part Dimensions

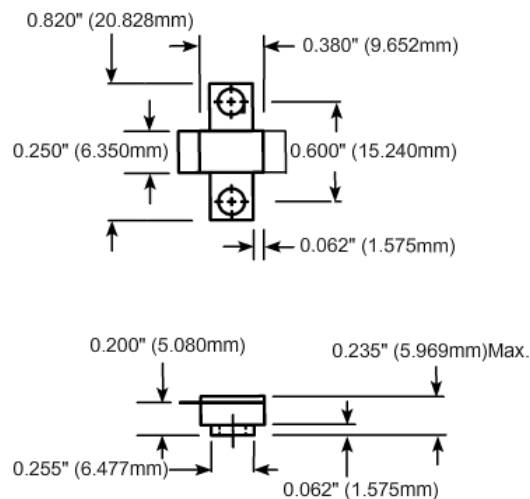

Component General, Inc.

P/N: CBR-125

Stripline Base Mounted Resistors

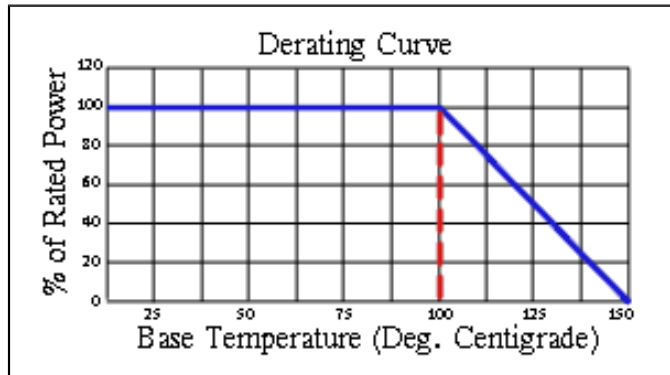
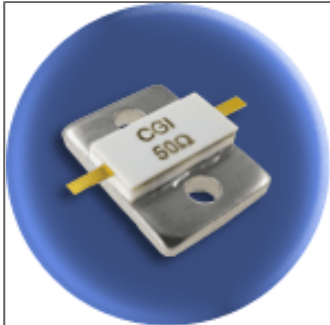

Mechanical Specifications

Covers:

Alumina Ceramic.

Substrate:

Beryllium Oxide Ceramic.

Contact:

Beryllium Copper, Gold Plated per MIL-G-45204.
Length: 0.125" Min., Width: 0.060",
Thickness 0.004" \pm 0.002".

Heat Sink:

Copper, Nickel Plated per QQ-N-290.

Tolerance:

\pm 0.010" unless specified.

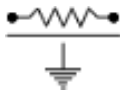

Note: The use of thermal mounting compound is recommended.

Electrical Specifications

Resistance Value:

10 - 1000 Ω or as required. Other values available upon request.

Frequency Range:

DC - 3.0 GHz

Standard Resistance Tolerance:

\pm 5% Other tolerances available upon request.

Part Dimensions

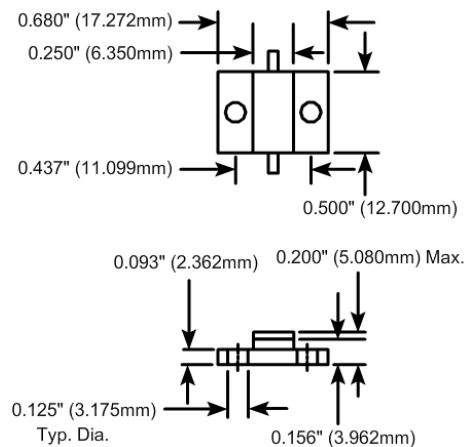

Component General, Inc.

P/N: CBR-150

Stripline Base Mounted Resistors

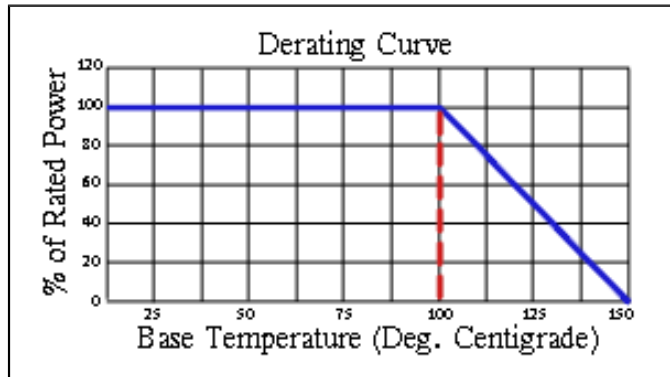
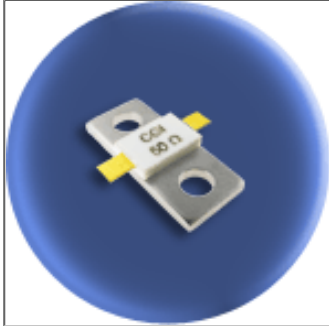

Mechanical Specifications

Covers:

Alumina Ceramic.

Substrate:

Beryllium Oxide Ceramic.

Contact:

Beryllium Copper, Gold Plated per MIL-G-45204.
Length: 0.125" Min., Width: 0.120",
Thickness 0.004" \pm 0.002".

Heat Sink:

Copper, Nickel Plated per QQ-N-290.

Tolerance:

\pm 0.010" unless specified.

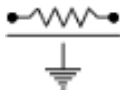

Note: The use of thermal mounting compound is recommended.

Electrical Specifications

Resistance Value:

10 - 1000 Ω or as required. Other values available upon request.

Frequency Range:

DC - 1.0 GHz

Standard Resistance Tolerance:

\pm 5% Other tolerances available upon request.

Part Dimensions

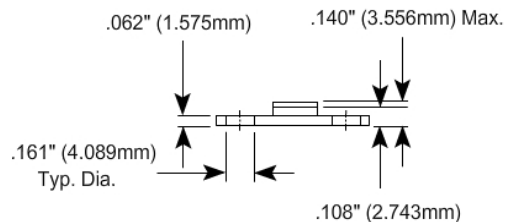
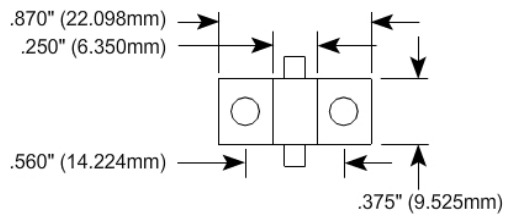

Component General, Inc.

P/N: CBR-150-1

Stripline Base Mounted Resistors

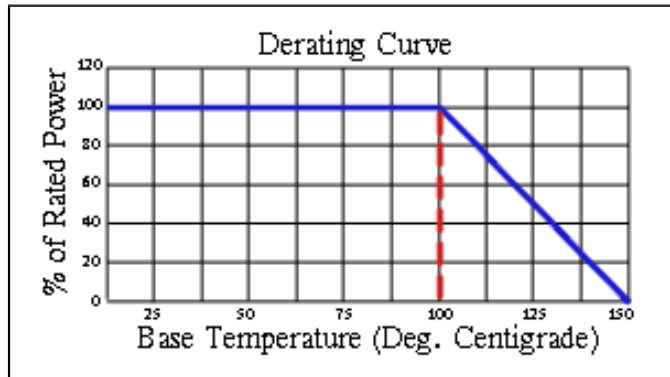
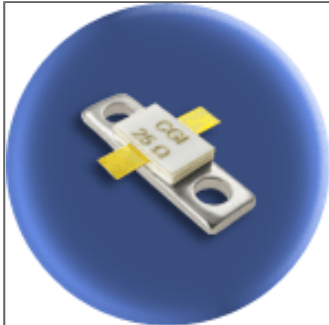

Mechanical Specifications

Covers:

Alumina Ceramic.

Substrate:

Beryllium Oxide Ceramic.

Contact:

Beryllium Copper, Gold Plated per MIL-G-45204.
Length: 0.125" Min., Width: 0.120",
Thickness 0.004" \pm 0.002".

Heat Sink:

Copper, Nickel Plated per QQ-N-290.

Tolerance:

\pm 0.010" unless specified.

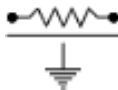

Note: The use of thermal mounting compound is recommended.

Electrical Specifications

Resistance Value:

10 - 1000 Ω or as required. Other values available upon request.

Frequency Range:

DC - 2.0 GHz

Standard Resistance Tolerance:

\pm 5% Other tolerances available upon request.

Part Dimensions

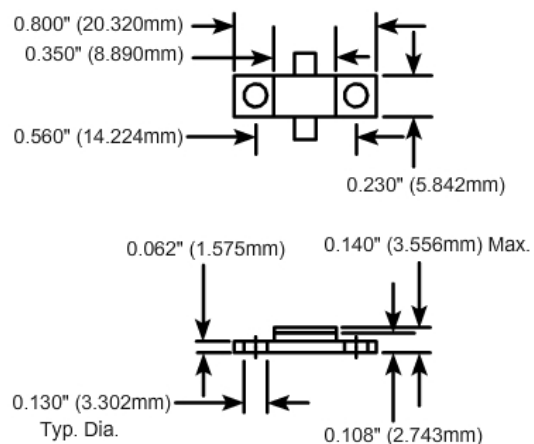

Component General, Inc.

P/N: CBR-150-2

Stripline Base Mounted Resistors

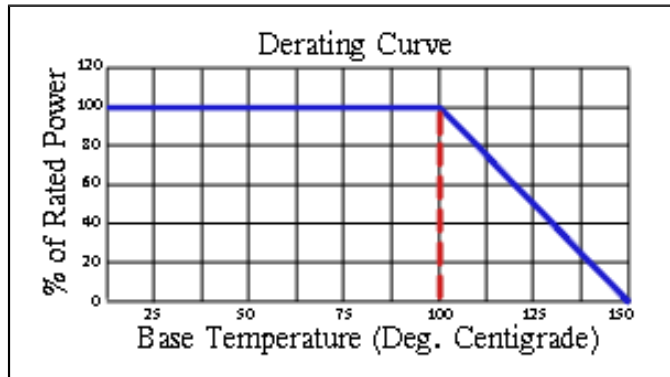
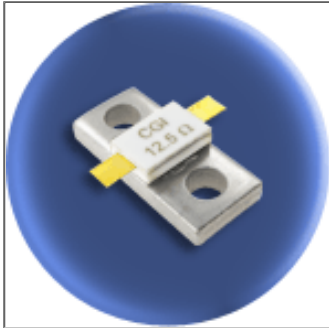

Mechanical Specifications

Covers:

Alumina Ceramic.

Substrate:

Beryllium Oxide Ceramic.

Contact:

Beryllium Copper, Gold Plated per MIL-G-45204.
Length: 0.125" Min., Width: 0.120",
Thickness 0.004" \pm 0.002".

Heat Sink:

Copper, Nickel Plated per QQ-N-290.

Tolerance:

\pm 0.010" unless specified.

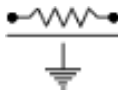

Note: The use of thermal mounting compound is recommended.

Electrical Specifications

Resistance Value:

10 - 1000 Ω or as required. Other values available upon request.

Frequency Range:

DC - 1.0 GHz

Standard Resistance Tolerance:

\pm 5% Other tolerances available upon request.

Part Dimensions

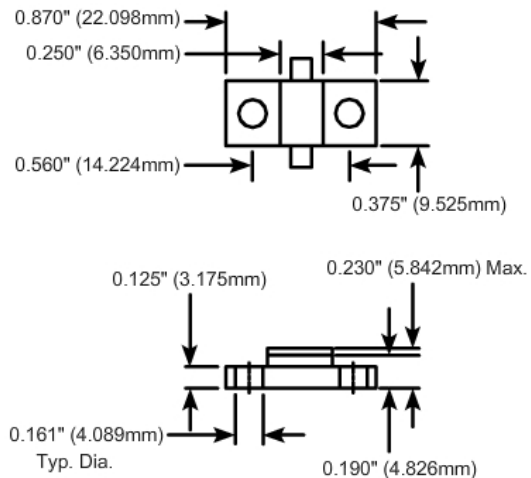

Component General, Inc.

P/N: CBR-150-3

Stripline Base Mounted Resistors

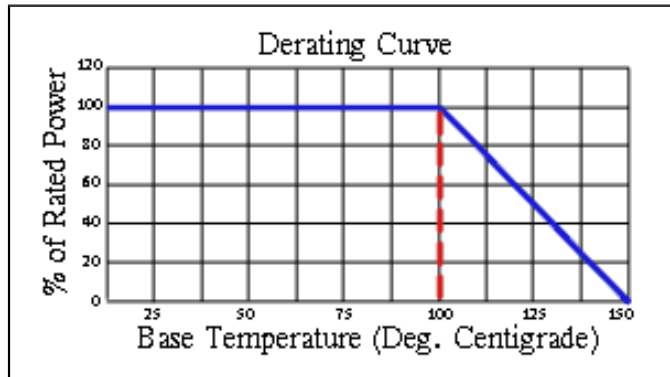
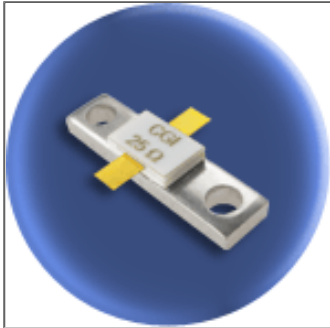

Mechanical Specifications

Covers:

Alumina Ceramic.

Substrate:

Beryllium Oxide Ceramic.

Contact:

Beryllium Copper, Gold Plated per MIL-G-45204.
Length: 0.125" Min., Width: 0.120",
Thickness 0.004" \pm 0.002".

Heat Sink:

Copper, Nickel Plated per QQ-N-290.

Tolerance:

\pm 0.010" unless specified.

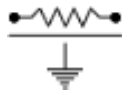

Note: The use of thermal mounting compound is recommended.

Electrical Specifications

Resistance Value:

10 - 1000 Ω or as required. Other values available upon request.

Frequency Range:

DC - 2.0 GHz

Standard Resistance Tolerance:

\pm 5% Other tolerances available upon request.

Part Dimensions

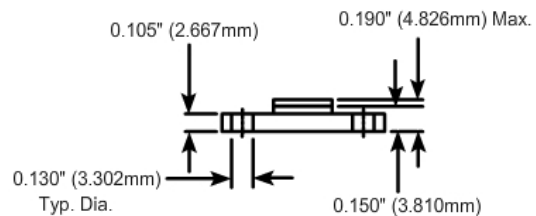
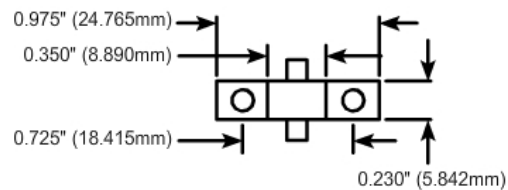

Component General, Inc.

P/N: CBR-150-4

Stripline Base Mounted Resistors

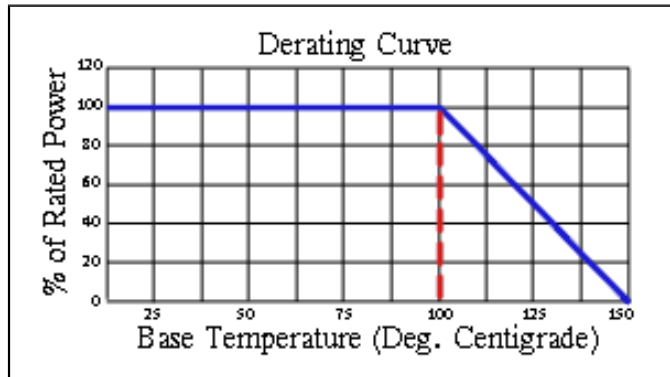
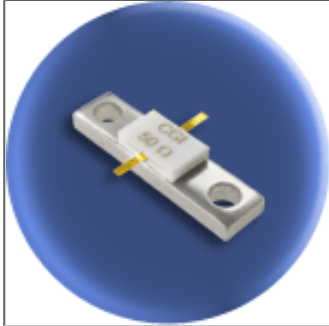

Mechanical Specifications

Covers:

Alumina Ceramic.

Substrate:

Beryllium Oxide Ceramic.

Contact:

Beryllium Copper, Gold Plated per MIL-G-45204.
Length: 0.125" Min., Width: 0.040",
Thickness 0.004" \pm 0.002".

Heat Sink:

Copper, Nickel Plated per QQ-N-290.

Tolerance:

\pm 0.010" unless specified.

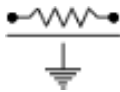

Note: The use of thermal mounting compound is recommended.

Electrical Specifications

Resistance Value:

10 - 1000 Ω or as required. Other values available upon request.

Frequency Range:

DC - 2.0 GHz

Standard Resistance Tolerance:

\pm 5% Other tolerances available upon request.

Part Dimensions

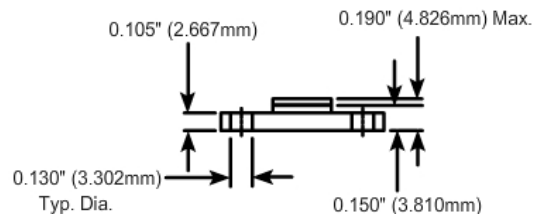
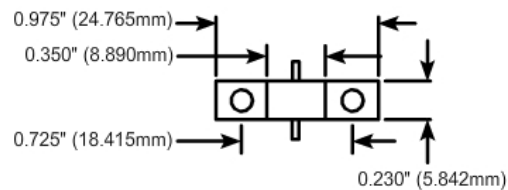

Component General, Inc.

P/N: CBR-150-5

Stripline Base Mounted Resistors

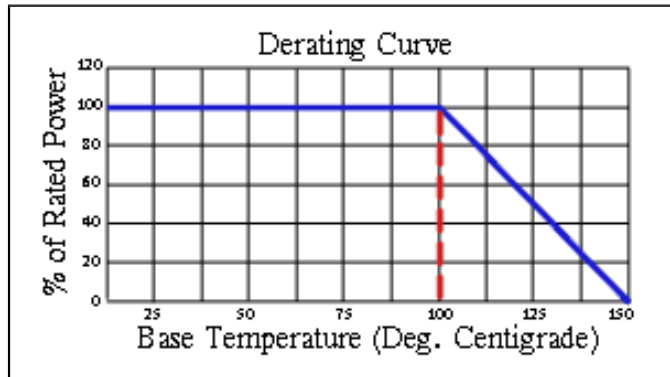
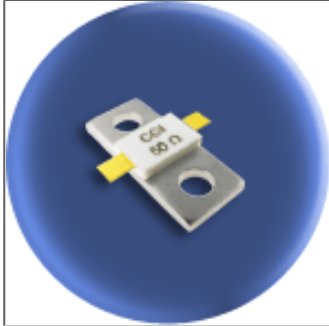

Mechanical Specifications

Covers:

Alumina Ceramic.

Substrate:

Beryllium Oxide Ceramic.

Contact:

Beryllium Copper, Gold Plated per MIL-G-45204.
Length: 0.125" Min., Width: 0.060",
Thickness 0.004" \pm 0.002".

Heat Sink:

Copper, Nickel Plated per QQ-N-290.

Tolerance:

\pm 0.010" unless specified.

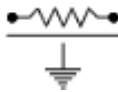

Note: The use of thermal mounting compound is recommended.

Electrical Specifications

Resistance Value:

10 - 1000 Ω or as required. Other values available upon request.

Frequency Range:

DC - 2.0 GHz

Standard Resistance Tolerance:

\pm 5% Other tolerances available upon request.

Part Dimensions

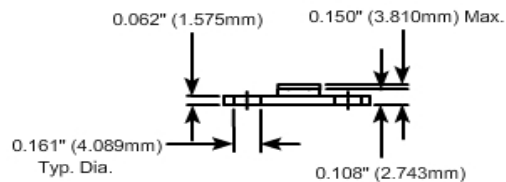
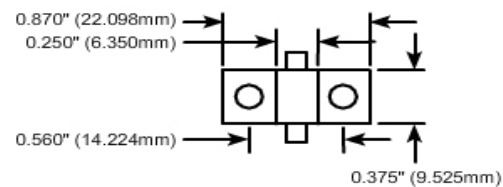

Component General, Inc.

P/N: CBR-250

Stripline Base Mounted Resistors

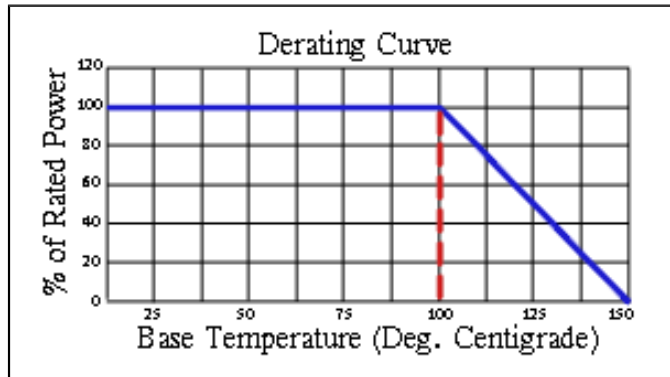
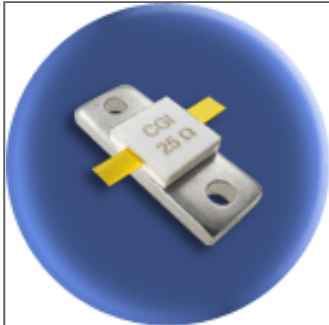

Mechanical Specifications

Covers:

Alumina Ceramic.

Substrate:

Beryllium Oxide Ceramic.

Contact:

Beryllium Copper, Gold Plated per MIL-G-45204.
Length: 0.125" Min., Width: 0.120",
Thickness 0.004" \pm 0.002".

Heat Sink:

Copper, Nickel Plated per QQ-N-290.

Tolerance:

\pm 0.010" unless specified.

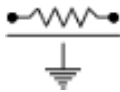

Note: The use of thermal mounting compound is recommended.

Electrical Specifications

Resistance Value:

10 - 1000 Ω or as required. Other values available upon request.

Frequency Range:

DC - 1.0 GHz

Standard Resistance Tolerance:

\pm 5% Other tolerances available upon request.

Part Dimensions

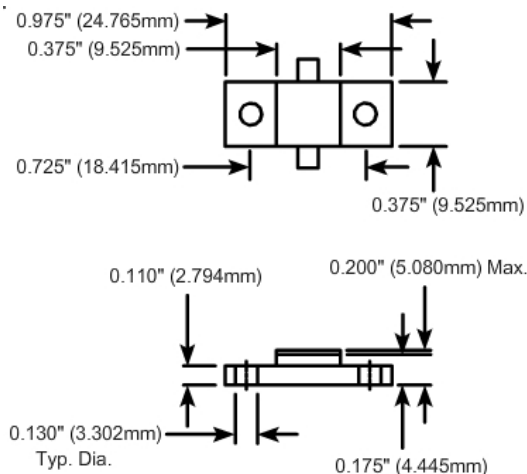

Component General, Inc.

P/N: CBR-250-1

Stripline Base Mounted Resistors

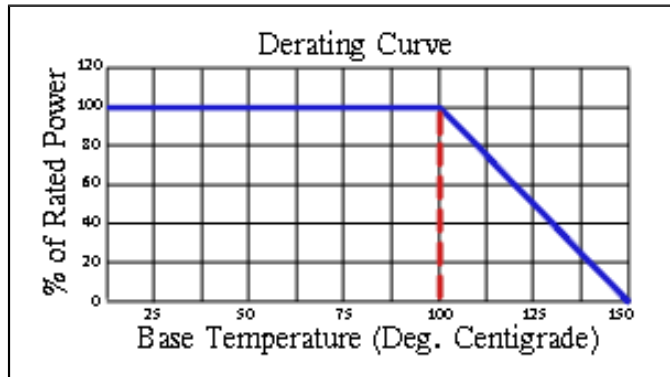
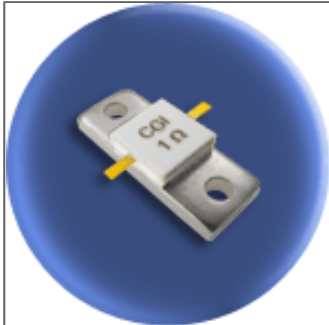

Mechanical Specifications

Covers:

Alumina Ceramic.

Substrate:

Beryllium Oxide Ceramic.

Contact:

Beryllium Copper, Gold Plated per MIL-G-45204.
Length: 0.125" Min., Width: 0.060",
Thickness 0.004" \pm 0.002".

Heat Sink:

Copper, Nickel Plated per QQ-N-290.

Tolerance:

\pm 0.010" unless specified.

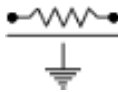

Note: The use of thermal mounting compound is recommended.

Electrical Specifications

Resistance Value:

10 - 1000 Ω or as required. Other values available upon request.

Frequency Range:

DC - 1.0 GHz

Standard Resistance Tolerance:

\pm 5% Other tolerances available upon request.

Part Dimensions

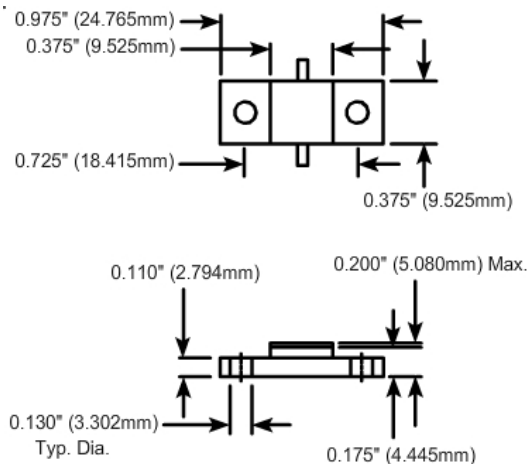

Component General, Inc.

P/N: CBR-250-2

Stripline Base Mounted Resistors

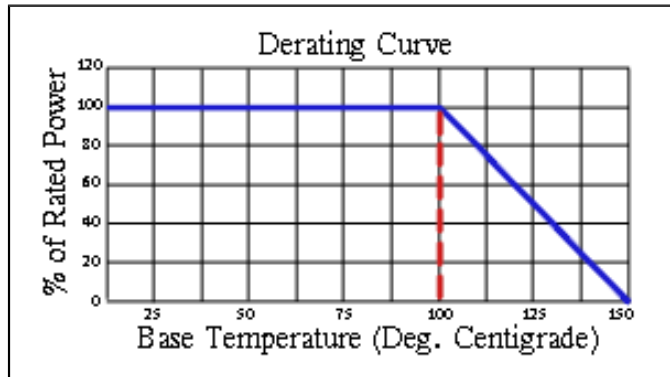
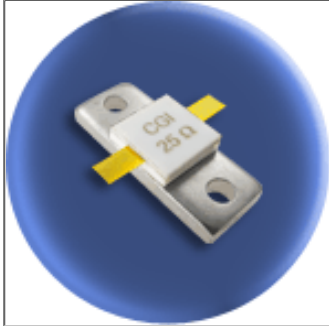

Mechanical Specifications

Covers:

Alumina Ceramic.

Substrate:

Beryllium Oxide Ceramic.

Contact:

Beryllium Copper, Gold Plated per MIL-G-45204.
Length: 0.125" Min., Width: 0.120",
Thickness 0.004" \pm 0.002".

Heat Sink:

Copper, Nickel Plated per QQ-N-290.

Tolerance:

\pm 0.010" unless specified.

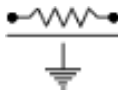

Note: The use of thermal mounting compound is recommended.

Electrical Specifications

Resistance Value:

10 - 1000 Ω or as required. Other values available upon request.

Frequency Range:

DC - 1.0 GHz

Standard Resistance Tolerance:

\pm 5% Other tolerances available upon request.

Part Dimensions

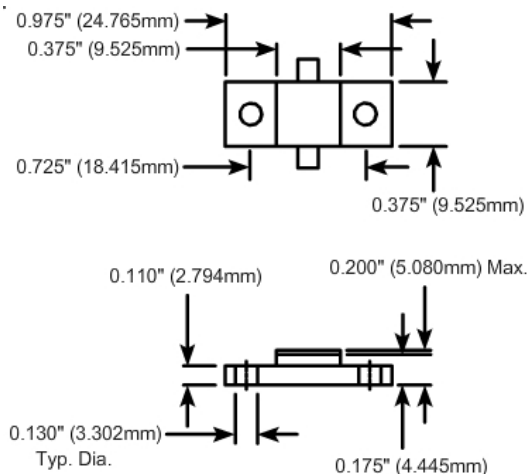

Component General, Inc.

P/N: CBR-250-4

Stripline Base Mounted Resistors

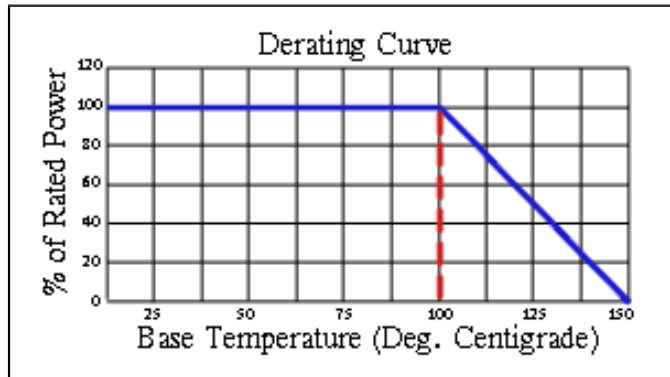
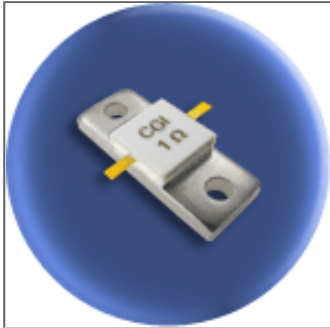

Mechanical Specifications

Covers:

Alumina Ceramic.

Substrate:

Beryllium Oxide Ceramic.

Contact:

Beryllium Copper, Gold Plated per MIL-G-45204.
Length: 0.200" Min., Width: 0.060",
Thickness 0.004" \pm 0.002".

Heat Sink:

Copper, Nickel Plated per QQ-N-290.

Tolerance:

\pm 0.010" unless specified.

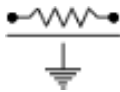

Note: The use of thermal mounting compound is recommended.

Electrical Specifications

Resistance Value:

10 - 1000 Ω or as required. Other values available upon request.

Frequency Range:

DC - 2.4 GHz

Standard Resistance Tolerance:

\pm 5% Other tolerances available upon request.

Part Dimensions

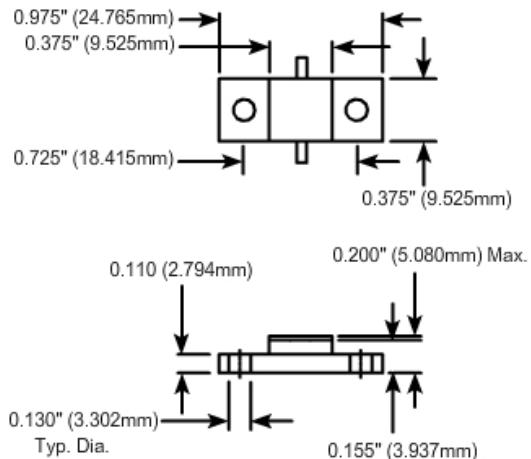

Component General, Inc.

P/N: CBR-250-5

Stripline Base Mounted Resistors

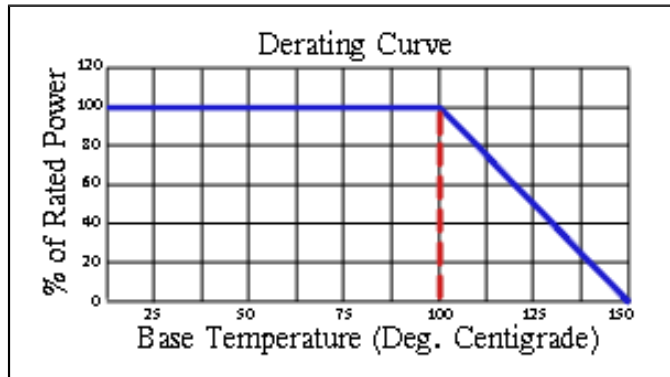
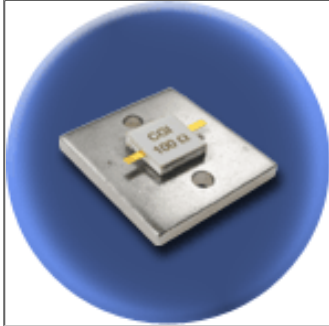

Mechanical Specifications

Covers:

Alumina Ceramic.

Substrate:

Beryllium Oxide Ceramic.

Contact:

Beryllium Copper, Gold Plated per MIL-G-45204.
Length: 0.125" Min., Width: 0.060",
Thickness 0.004" ± 0.002".

Heat Sink:

Copper, Nickel Plated per QQ-N-290.

Tolerance:

± 0.010" unless specified.

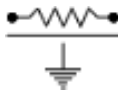

Note: The use of thermal mounting compound is recommended.

Electrical Specifications

Resistance Value:

10 - 1000 Ω or as required. Other values available upon request.

Frequency Range:

DC - 2.4 GHz

Standard Resistance Tolerance:

± 5% Other tolerances available upon request.

Part Dimensions

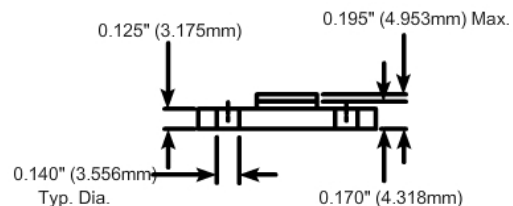
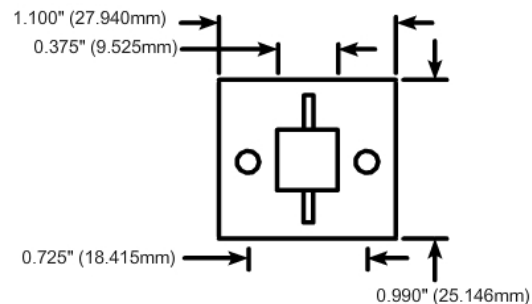

Component General, Inc.

P/N: CBR-370

Stripline Base Mounted Resistors

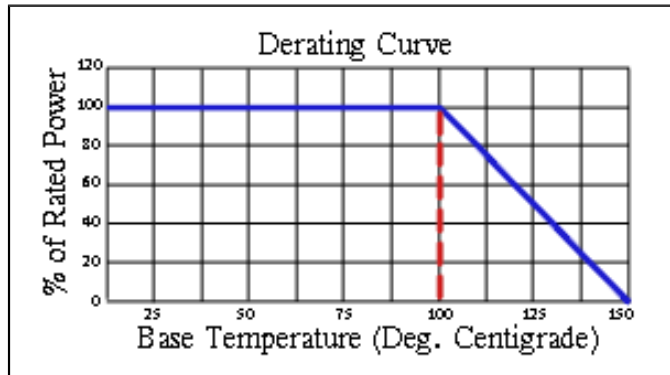
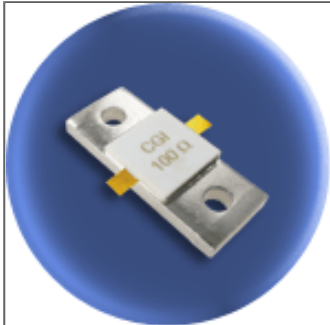

Mechanical Specifications

Covers:

Alumina Ceramic.

Substrate:

Beryllium Oxide Ceramic.

Contact:

Beryllium Copper, Gold Plated per MIL-G-45204.
Length: 0.125" Min., Width: 0.120",
Thickness 0.004" \pm 0.002".

Heat Sink:

Copper, Nickel Plated per QQ-N-290.

Tolerance:

\pm 0.010" unless specified.

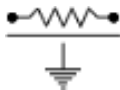

Note: The use of thermal mounting compound is recommended.

Electrical Specifications

Resistance Value:

10 - 1000 Ω or as required. Other values available upon request.

Frequency Range:

DC - 0.75 GHz

Standard Resistance Tolerance:

\pm 5% Other tolerances available upon request.

Part Dimensions

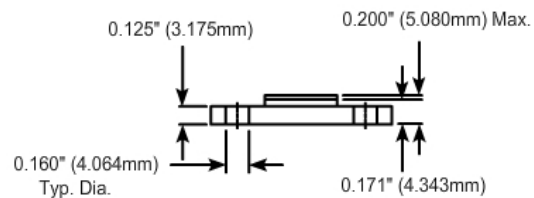
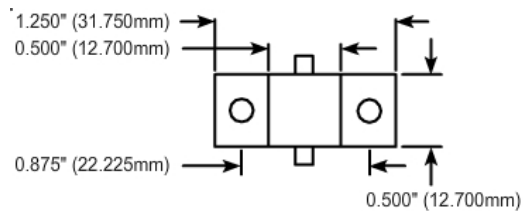

Component General, Inc.

P/N: CBR-400

Stripline Base Mounted Resistors

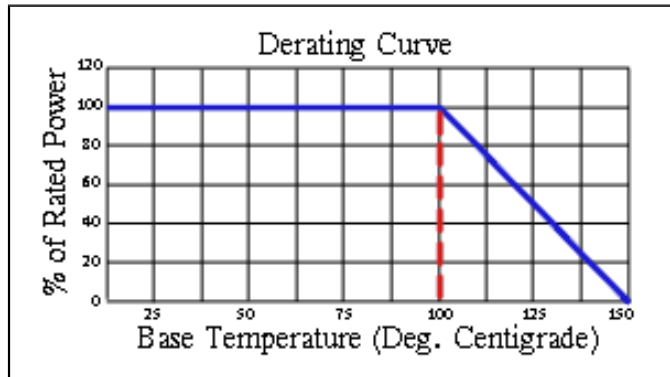
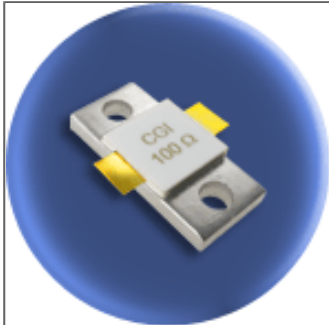

Mechanical Specifications

Covers:

Alumina Ceramic.

Substrate:

Beryllium Oxide Ceramic.

Contact:

Beryllium Copper, Gold Plated per MIL-G-45204.
Length: 0.125" Min., Width: 0.250",
Thickness 0.004" \pm 0.002".

Heat Sink:

Copper, Nickel Plated per QQ-N-290.

Tolerance:

\pm 0.010" unless specified.

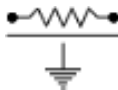

Note: The use of thermal mounting compound is recommended.

Electrical Specifications

Resistance Value:

10 - 1000 Ω or as required. Other values available upon request.

Frequency Range:

DC - 0.75 GHz

Standard Resistance Tolerance:

\pm 5% Other tolerances available upon request.

Part Dimensions

